

A device for static and/or dynamic identification tests on foundation piles

Giuseppe Oliveto, Giuseppe Buda and Pietro Sciacca

Department of Civil and Environmental Engineering, Structural division,
University of Catania, Catania, Italy

Abstract. This work describes the design and construction process of an experimental device for static and/or dynamic identification tests on foundation piles. The aim is to provide information on the behaviour of soil-pile systems subject to seismic action. The primary objective is the validation of numerical models currently available for research purposes pointing out inevitable shortcomings and outlining aspects that should be investigated in detail in the near future. In this respect this paper is closely related to a companion one on numerical aspects published in this same volume. The device is specifically designed for the application of horizontal forces and couples to pile heads. Besides the evaluation of the limiting values of dynamic parameters, generally speaking stiffness and flexibility coefficients, static tests have the objective of identifying the viscoelastic behaviour of the system through creep tests. The experimental tests carried out by means of this prototype device will provide an opportunity to gather information not only on the global behaviour of the soil-pile system but also on the strain and stress state within the pile stem and indirectly within the soil.

1 Introduction

The experience gained by the research group in Catania on static and dynamic testing of soil-structure interacting systems, such as full scale buildings and foundation rafts on piles, has shown to the complexity of the problem and has suggested the design and execution of a simpler research programme addressing the simplest of the structural systems. Within the field of foundations on piles this may be identified as the single pile-soil system.

In such a case, even only for the static field, the behaviour under horizontal loads is still little known. For this reason our choice has been on the identification of the static and dynamic behaviour of the single pile-soil system under horizontal loads. Therefore it has appeared appropriate to design and construct an experimental device with the capability of applying horizontal forces and/or couples to pile heads.

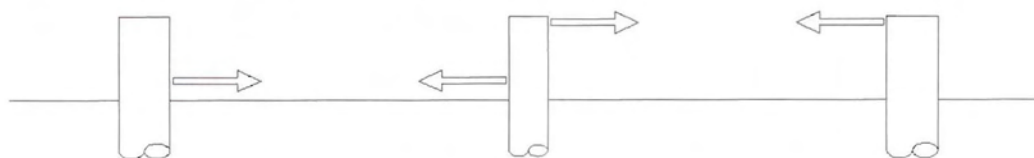

Figure 1. Schematic view of the test system.

For reasons of economy a device which could apply at the same time horizontal forces on some piles and couples on others has been conceived. In this way the single piles, besides constituting test specimens, provide contrast to the other piles. The basic scheme is shown in Figure 1.

Three aligned piles are set at such a distance that the pile-soil-pile interaction turns out to be negligible. The end piles are subject to horizontal forces applied at different heights; the central pile, through appropriate gearing, is subjected to a pure couple. It is evident that the testing system is a closed one and that each pile provides contrast to the other two. The above description illustrates the basic idea. In the following, the various elements that have had to be designed and constructed to realize the basic idea will be presented. At this point it should be emphasised that the above description explains readily only the static part of the experiments and perhaps the part concerning time delayed effects (viscous behaviour, creep tests). However nothing has been said about the dynamic nature of the test. This is activated at the end of each static test by the sudden release of the applied forces by the breaking of a properly designed weak link inserted within the testing device. Because the test results are to be used to assess the reliability of numerical algorithms for the description of the static and/or dynamical behaviour of the soil-pile system it has seemed appropriate to include in the experimental programme a series of tests intended to find the characterisation of the pile and of the soil. Therefore, besides the description of the basic experimental device, in the following the tests and instrumentation used to characterise the pile and the soil will also be briefly illustrated.

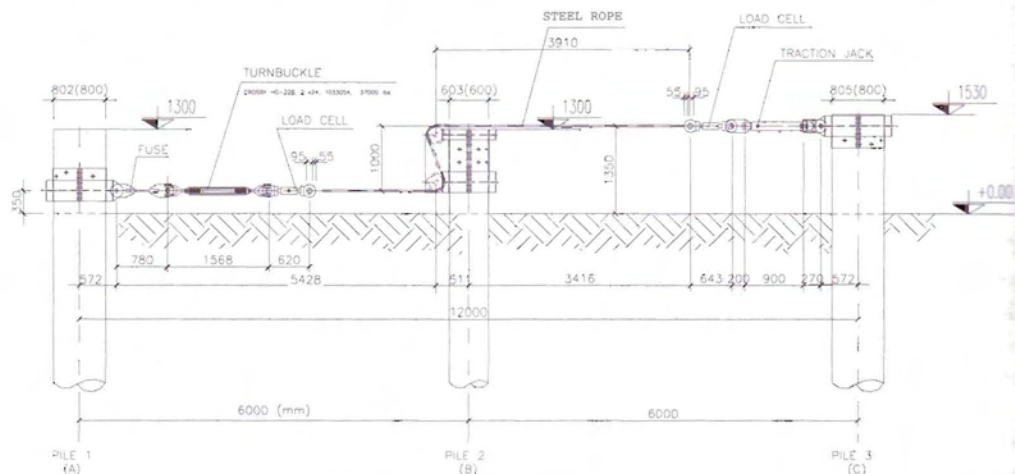

Figure 2. Components of the testing device.

2 Description of the test device

The elements which related to the constitution of the test device are shown schematically in Figure 2. They are listed below:

1. three collars to attach to the pile heads;
2. one steel rope for load transmission;
3. two pulleys to change load height and direction for couple application;
4. one traction jack for application of horizontal load;
5. two load cells to measure load in each branch of the load transmission rope;
6. One turnbuckle for fine tuning initial configuration (rope in horizontal position with no applied load);
7. Quick release device (fuse).

The device is useless in the absence of reaction and test piles. In the present case these have been built as test piles within the construction of the Teaching Activities Building of the Engineering Faculty at the University of Catania. The research group is grateful to the University of Catania for providing the test site, the piles and for allowing the testing activities. The description of the piles will be part of a following paragraph.

2.1 Pile head collars

The collars needed to engage pile heads have different characteristics for each pile. The differences are essentially related to the type of load to be applied and to the elements to be connected. With reference to Figure 2, the end piles are subject to horizontal forces applied at different heights. In principle there should be no need for any difference between the two collars; however they appear with the characteristics shown in Figure 3 and in Figure 4.

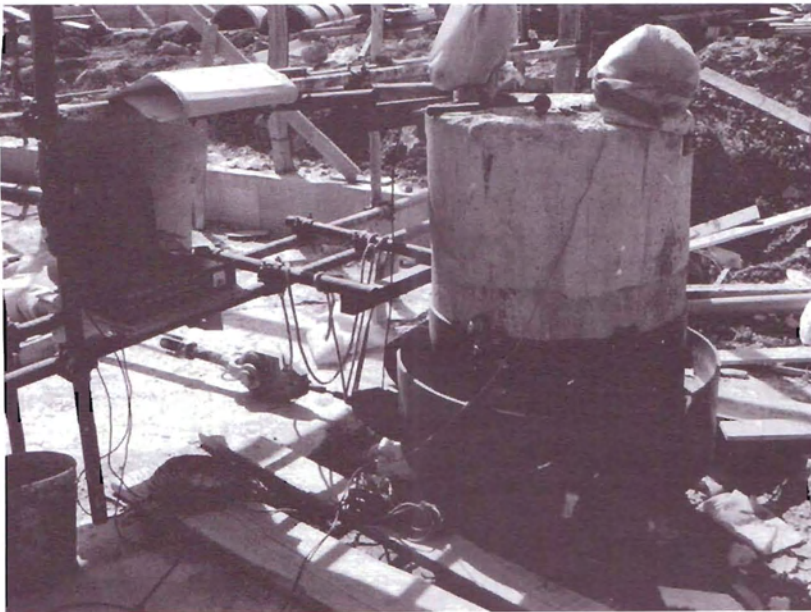

Figure 3. Collar on pile n°1.



Figure 4. Collar on pile n° 3.

The collar for pile n°1 in Figure 2 is shown in Figure 3, while the collar for pile n°3 is shown in Figure 4. It may be observed how the collars are essentially identical, although for loading requirements they are mounted in a symmetrical configuration. Owing to the fact that the force must be applied at a lower height, through collar n°1 it is mounted as in Figure 3, while an equal and opposite force must be applied at a greater height through collar n°3; therefore it is mounted as in Figure 4. Both are built as half-cylinders properly stiffened and provided with attachment devices. After positioning by means of a site fork-lift the two half-cylinders are tied together by means of high strength bolts.

As may be seen from Figure 4, the traction jack for the load generation is attached to the collar for pile n°3. At the other end the quick release device (fuse) is attached on one side to the collar on pile n°1 and on the other to a CROSBY turnbuckle model HG-228, as may be seen in Figures 3, 9 and 10.

The collar for the central pile is shown in Figure 5. Special characteristics of this collar are the supports for the two pulleys used to change the steel rope alignment. This has resulted in a larger height of this collar with respect to the other two, especially in order to provide a suitable lever arm for the application of the couple. Additional dimensional differences are apparent because the central pile has a diameter of 600 mm while the end piles have a diameter of 800mm. The choice of dimensions arose from the need to test both types of piles used in the foundation of the TA building of the Faculty of Engineering at the University of Catania. As was the case for the other two collars the one for the central pile consists of two half-cylinders tied together by means of high strength bolts. The fastening system and the rope alignment system are both clearly visible in Figure 5.

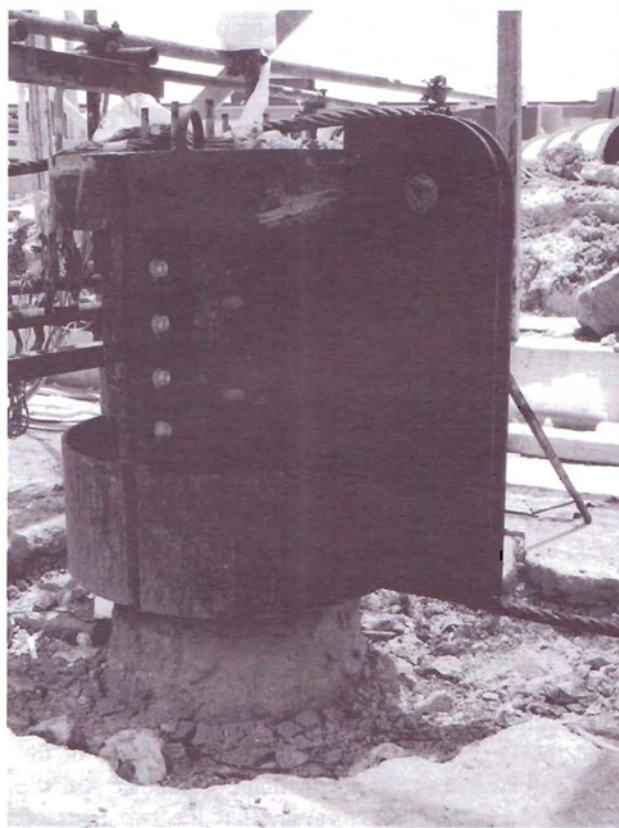

Figure 5. Collar on pile n°2.

2.2 The steel rope

The steel rope is a fundamental component of the testing device because of its function of load transmission. The size and mechanical characteristics of the rope have been evaluated as a function of the maximum testing load. The evaluation of the latter forms the object of an appropriate paragraph. The characteristics of the steel rope, as provided by the manufacturer, are:

- nominal diameter 32 mm;
- length 7048 mm;
- operational load 172 kN;
- safety margin 6;
- tested in our laboratory up to $T = 344$ kN.

The rope was manufactured and assembled by CERTEX UK Ltd in the required design length with end fittings G416 CROSBY for the connection to the load cells for the load measurement.

Part of the rope is visible in Figure 7 when passing on top of the central pile, while one end with end fitting and eye connector to a load cell is visible in Figure 6.



Figure 6. Rope end with fitting.

2.3 The pulleys

The function of the pulleys is to displace the steel rope path in such a way as to apply a couple to the central pile. Especially important for that purpose is the pulley rotation so that the rope may slide freely and the same traction be applied at both ends of the rope. The inevitable friction and mounting defects makes this aim difficult to achieve. A first prototype of the pulley system displayed an unacceptable load difference at the two ends of the rope. Successive mounting improvements have led to a diminution in the traction unbalance but the improvement obtained has not been considered sufficient for the aims of the experiment. For this reason a new pair of pulleys has been constructed with the inclusion of suitable bearings to minimise friction and traction unbalance.



Figure 7. Change of the steel rope path via pulleys.

2.4 The traction jack

The traction jack type COT30N300X, built by EURO PRESS PACK s.r.l. (Genoa – Italy), is visible in Figure 4. This is a fundamental component of the test system; besides providing the force to be applied to the pile head, it must have a long enough stroke to accommodate the displacement at the pile heads. The chosen jack can apply a maximum load of 324 kN at a pressure 700 bar for a maximum stroke of 300 mm. These values cover very well the theoretical range of the test parameters which requires a maximum load of 150 kN for a maximum stroke not larger than 15 mm. On the theoretical prediction of the maximum displacement at pile heads and therefore on the required jack stroke, see the parallel article in this volume [Vinciprova, Maeso Fortuny, Aznárez and Oliveto].

2.5 The load cells

Two traction load cells for static and dynamic measurements have been built on the design specifications of the research group by NOVATECH Measurements Ltd (England). One of the two load cells is shown in Figure 8. The purpose of the cells is the correct evaluation of the forces applied to the pile heads both in static and dynamic conditions. In particular it may occur that is applied only a couple or a couple plus a horizontal force to the central pile. For that reason the two load cells have been placed at the two ends of the steel rope respectively in the section between piles 1 and 2 and in the section between piles 2 and 3. Particularly important, in view of the size of the cells and of the transmitted load, are the connectors which link the cells to the steel rope and other components of the test system: the tumbuckle in the vicinity of pile n°1 and the traction jack close to pile n°3. Such connections are clearly visible in Figure 8.



Figure 8. Load cell type F204 built on request by NOVATECH Ltd.

The characteristics of the load cells are as follows:

- load range 0 – 500 kN;
- non-linearity 0.15% maximum load;
- repeatability 0.02% maximum load.

The characteristics of the eye connectors M64x3 mm type BS4278 are:

- operational load 200 kN;
- safety margin 5.

2.6 The turnbuckle

In order to facilitate the assembling and mounting operations the length of the steel rope is slightly larger than the minimum required. Therefore the total length of the system chain exceeds by a small amount the distance between the heads of the end piles. The resulting sag is removed by means of the CROSBY turnbuckle type HG-228 supplied by CERTEX UK Ltd, Figure 9. As provided by the manufacturer, the characteristics of the turnbuckle are:

- weight 420 N;
- operational load 168 kN;
- safety margin 5;
- tested in our laboratory at $T = 420$ kN;
- length 1940/1340 mm.

The presence of such a component is fundamental in order to preserve the jack stroke for the loading operations. The nominal length which can be recovered by the turnbuckle is ± 300 mm. The type of turnbuckle was selected on the basis of its maximum regulation length and of the maximum transmissible load. In the assembly phase the turnbuckle is inserted in the configuration of maximum extension allowing for a maximum recoverable length of 600 mm.



Figure 9. CROSBY turnbuckle type HG-228 for sag removal.

2.7 The quick release device (fuse)

The quick release device shown in Figure 10 is fundamental for the application of dynamic actions. In fact it allows the execution of free vibration tests under different amplitudes of the imposed displacement. Such a device is built starting from a high strength steel bar, therefore

having a limited rupture strain, by reducing the cross section until the required rupture load is obtained. On the basis of the mechanical characteristics of the material and ad-hoc laboratory tests, the strength is regulated in such a way that rupture occurs at not more than 10% above the maximum load specified for the corresponding static test. Once the static test has been completed, the load is increased rapidly until the rupture of the device occurs with the sudden load release and subsequent free oscillation of the system. The fuse is clearly visible in the photograph on the right of Figure 10 while in the photograph on the left is visible in the assembled configuration.

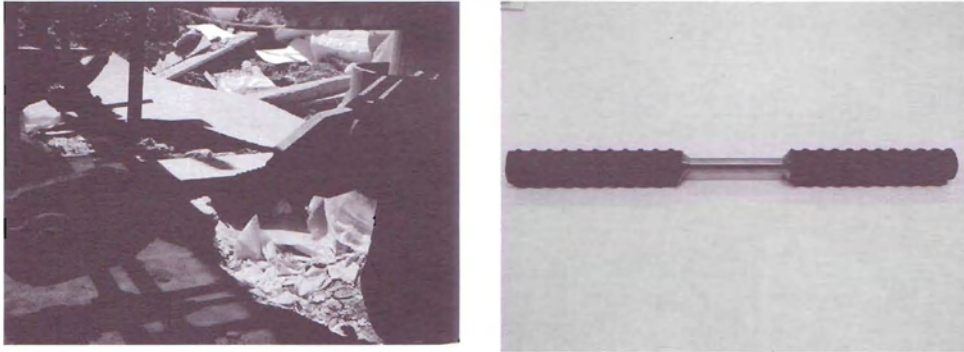

Figure 10. Quick release device designed and calibrated by laboratory staff. Right: calibrated fuse; left: fuse in assembled configuration.



Figure 11. Components of the test device between pile n° 1 and pile n° 2; starting from pile n° 1 are visible the quick release device, the CROSBY turnbuckle, the load cell and the steel rope passing over pile n° 2. The support structure for the displacement transducers is also visible in the vicinity of pile n° 1.

An overall view of the test device is visible in the photographs of Figures 11 and 12. In Figure 11 the components between pile n° 1 are visible, and pile n°2 to the left in the photograph,. In Figure 12, instead the elements between pile n°3 are visible, and pile n°2 to the right on the photograph,; in the background pile n°1 is also visible.

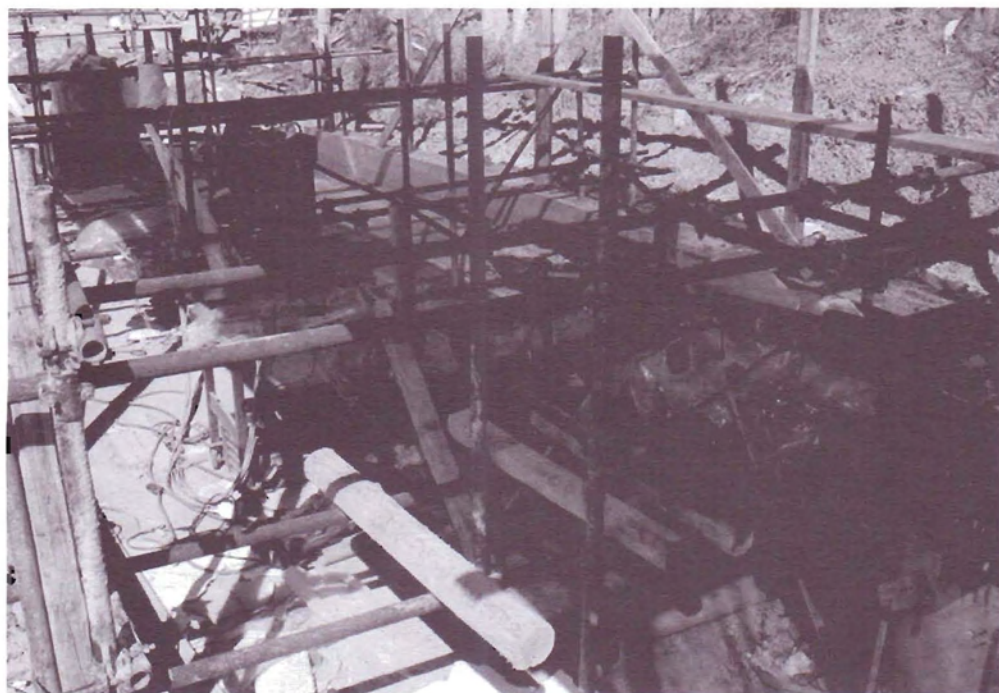

Figure 12. Components of the test device between pile n°2 and pile n°3. Starting from pile n°3, to the right in the photograph, the traction jack, the load cell and the steel rope passing on pile n°2 are visible. In the vicinity of pile n°3 the support structure for the displacement transducers is also visible. In the background pile n°1 is visible.

3 The test piles

As was mentioned earlier, the construction of the TA building of the Engineering Faculty at the University of Catania provided the opportunity for the execution of the present test series; in fact, the test piles and the test site were provided by the University of Catania within the previously mentioned contract. The test results will be used within the building certification procedure. The test piles were built in the immediate proximity of the building which is founded on piles. As it has been previously mentioned, the test piles were built along one alignment at a relative distance, centre to centre, of 6.00 m. The end piles have a diameter of 800 mm while the central pile has a diameter of 600 mm. In this way the two types of piles used in the construction of the building foundation will be both tested. The design length of the two

pile is 25.00 m. The reinforcement bars and other design details are shown in the drawings of Figure 13 for the 800 mm pile and in the drawings of Figure 14 for the 600 mm pile. The piles are of the type bored and cast on site. The longitudinal reinforcement is uniform over all the length of the pile apart from a terminal section near the pile head, where the reinforcement area is doubled. As shown in Figure 13, the 800 mm piles are reinforced with 10 bars of nominal diameter 20 mm while the 600 mm piles are reinforced with 8 bars of nominal diameter 16 mm, see Figure 14. In both cases the number of bars doubles in the terminal section near the pile heads, as is clearly shown in the drawings of Figures 13 and 14. For both pile types the transversal reinforcement is helical with 30 cm pitch and 8 mm diameter.

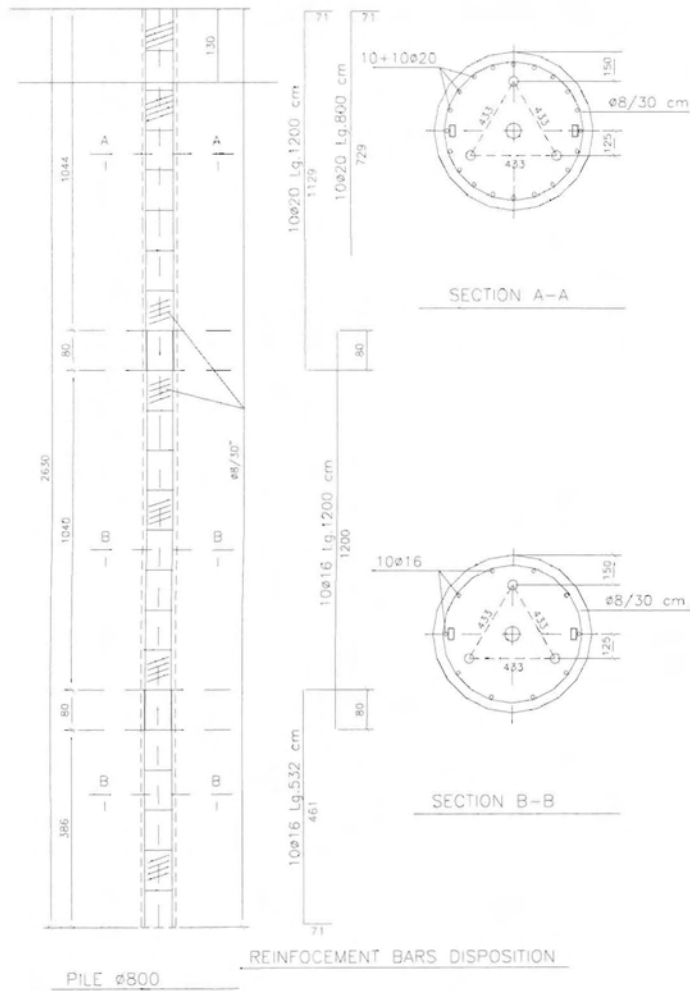

Figure 13. Reinforcement details for the piles of diameter 800 mm.

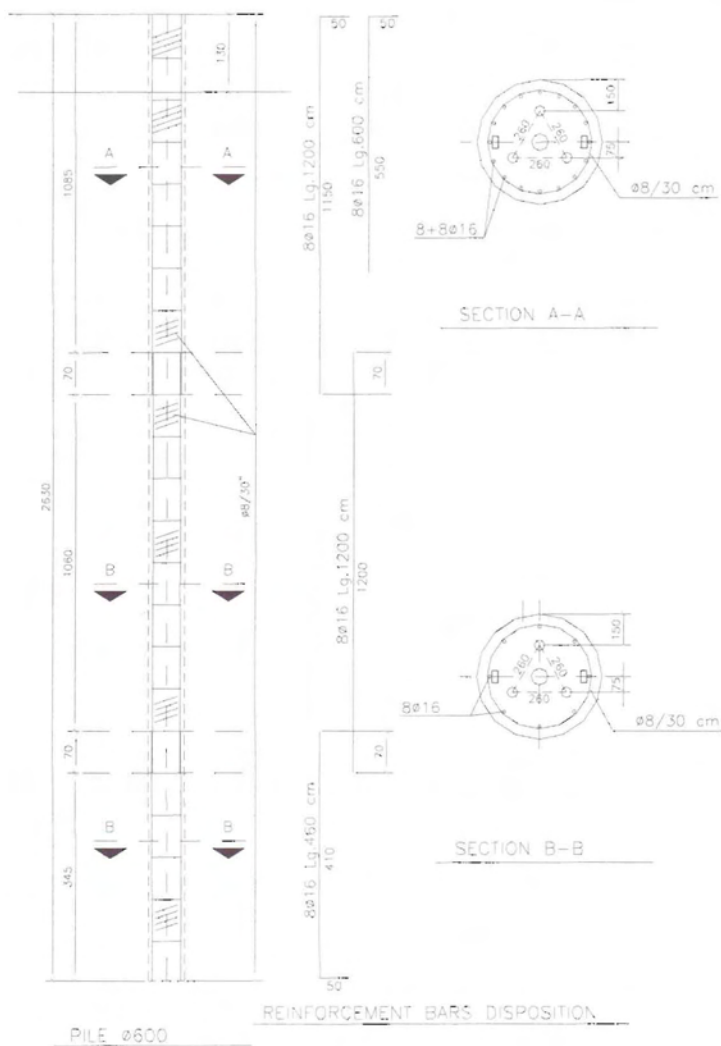

Figure 14. Reinforcement details for the piles of diameter 600 mm.

3.1 Materials testing

Within the certification procedure for the TA building of the Faculty of Engineering, concrete and reinforcement steel samples have been collected on site and tested according to present regulations. The concrete strength, evaluated on the basis of 20 samples, has exhibited a mean value of 29 N/mm^2 and a standard deviation 5 N/mm^2 . The results of the tests conducted on the

steel samples allow the classification of the material as Fe 44k according to the current Italian classification. In addition to the previously quoted laboratory tests, ultrasonic tests have been performed in order to verify casting quality and pile integrity. For this purpose each test pile has been fitted with 3 PVC pipes of diameter 50 mm and positioned as shown in the drawing of Figure 15. In the same figure there is a photograph where the longitudinal disposition of the three pipes is shown. The central pipe of diameter 80 mm should have allowed cross-hole seismic tests from pile to pile. Unfortunately, due to the contractor's negligence, these pipes have been found obstructed and not usable for the original purpose.

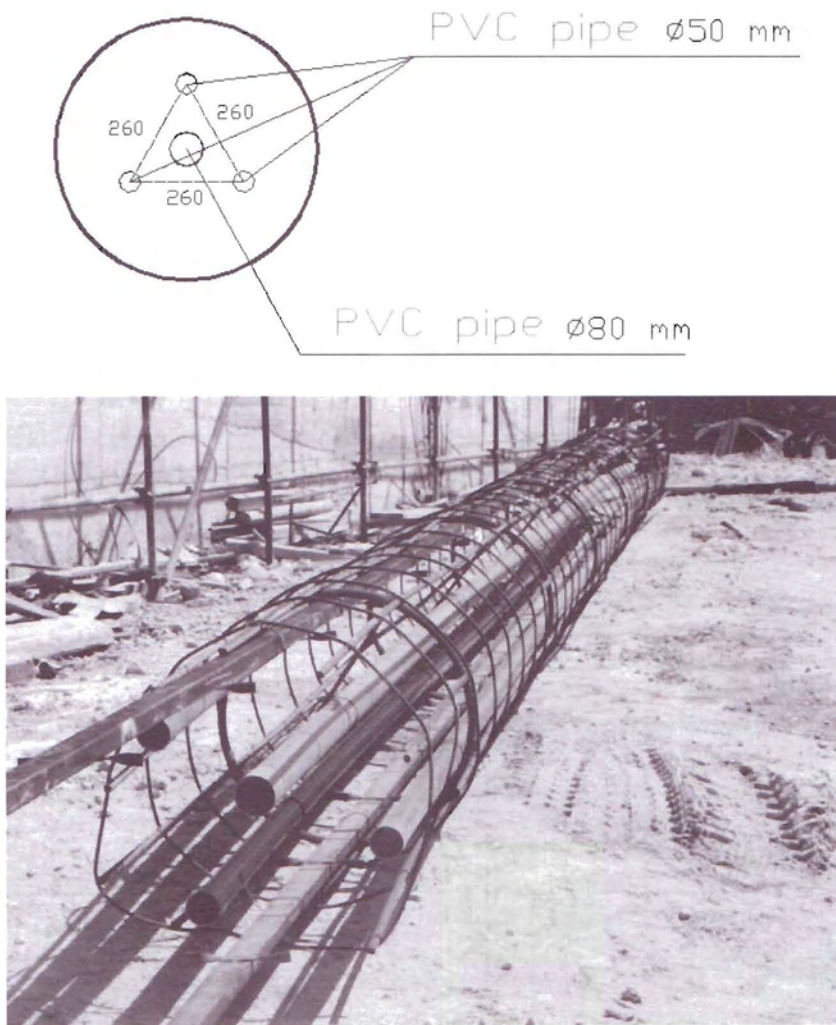

Figure 15. Configuration of PVC pipes for cross-hole ultrasonic tests.

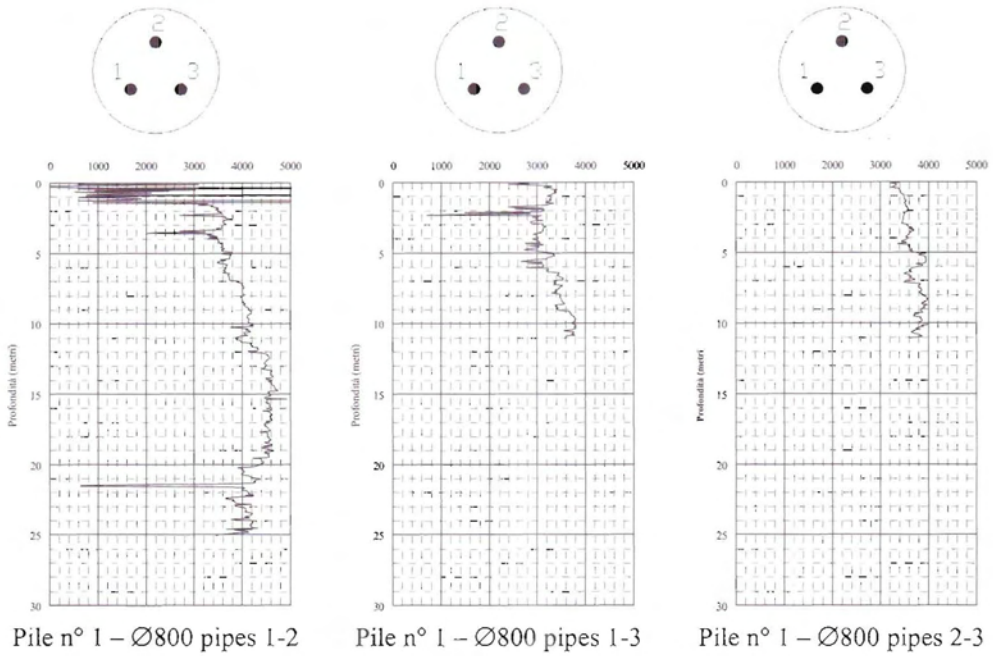

Figure 16. Ultrasonic tests on pile n° 1, diameter 800 mm - P wave velocity in m/s.

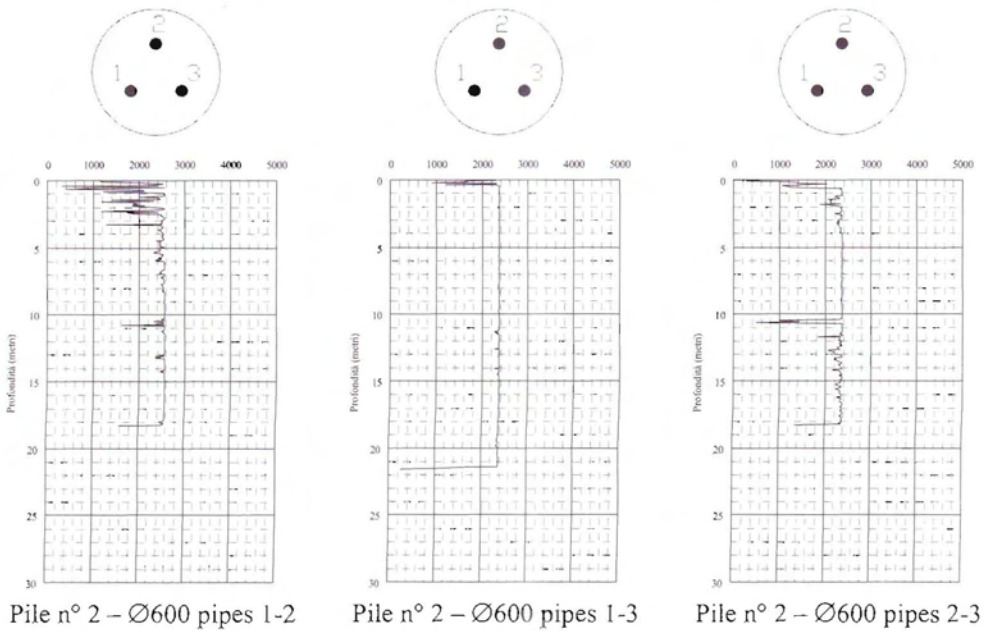

Figure 17. Ultrasonic tests on pile n° 2, diameter 600 mm - P wave velocity in m/s.

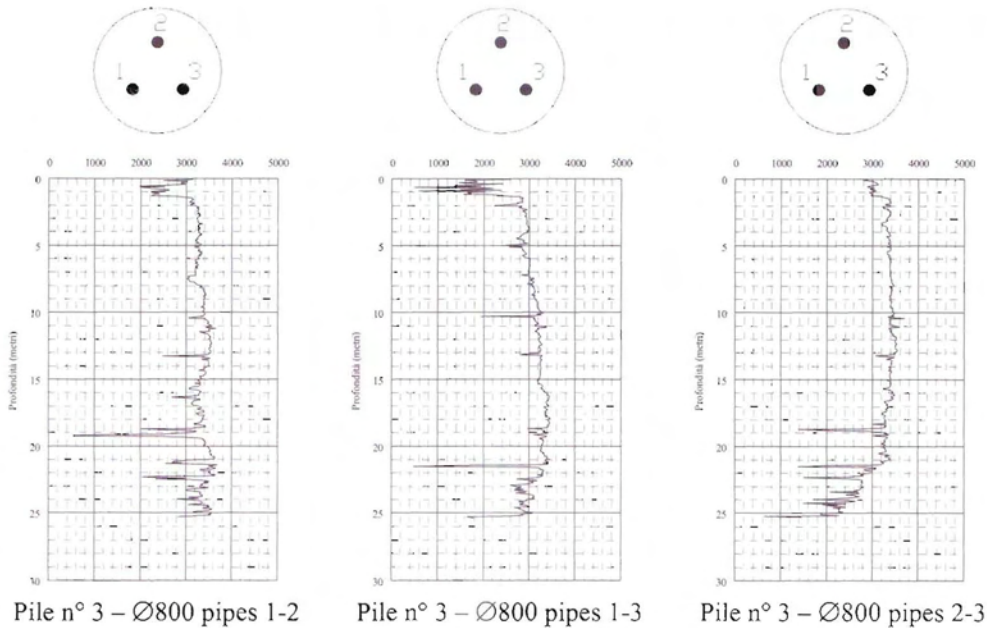

Figure 18. Ultrasonic tests on pile n° 3, diameter 800 mm - P wave velocity in m/s.

Pile casting occurred on 15 July 2002 while the ultrasonic integrity tests were performed on 9 September 2002. The results are shown in Figure 16 for pile n°1, in Figure 17 for pile n°2 and in Figure 18 for pile n°3. Again because of the contractor's negligence, pipe n°3 for the execution of the ultrasonic tests in pile n°1 showed an obstruction at the depth of 11.05 m. Nevertheless the ultrasonic tests have provided invaluable information on the casting quality and on the mechanical properties of concrete. The irregularities in the velocity profiles are more likely attributable to measurement defects than to casting vagaries. In fact, inevitable deformations of the PVC pipes, possibly responsible for the observed obstruction, may have determined significant variations in the distance between couples of pipes. This distance is obviously reflected in the determined wave velocity. At any rate a longitudinal wave velocity in the range 3000 m/s ÷ 4000 m/s may be considered acceptable for the considered piles.

With reference to pile n°2 an obstruction has been reported at the depth of 18.30m in pipe n°2, while an obstruction was found at the depth of m 21.80 in pipe n°3. For the length of pile that was possible to examine the wave velocity was found in the range 2400 ÷ 2600 m/s. These values are rather out of range, especially if compared with those for piles n°1 and n°3; therefore a repetition of the tests is advisable in order to confirm or disprove the presently available results.

With reference to pile n°3 it is worth noticing that it was possible to perform the tests for the complete length. In this case the wave velocity was in the range 3000 ÷ 3400 m/s. At any rate the ultrasonic tests will soon be repeated on all the test piles also in order to detect possible variations in the wave velocity eventually due to concrete maturing.

3.2 Curvature measurements

The test piles have been instrumented in such a way as to measure curvatures at discrete points along the pile length. Two channel shaped profiles have been placed in the pile as shown in the drawing of Figure 19. These profiles were fitted with spearheads to ensure better adherence to the concrete. The channel shape is useful on one hand to bind the strain gauges on the inner side of the web and on the other to channel the electric cables that carry the signals to the data acquisition system. Once all the strain gauges and corresponding electrical cables have been fixed, the channel is filled with polyurethane foam and then covered with a lid which is welded to the channel profile. In this way the open channel profile becomes a closed one which protects the strain gauges and electric cables during casting operations and later on. A schematic representation of the apparatus described is shown in Figure 20. In Figure 20, two photographs show the channel profiles, the spearheads, the welded lid and the polyurethane foam. From one of the two channels the electric cables and a connector are seen to emerge. In the photograph on the right of Figure 20 the bundles of cables, emerging from the two channel profiles, and connectors are visible.

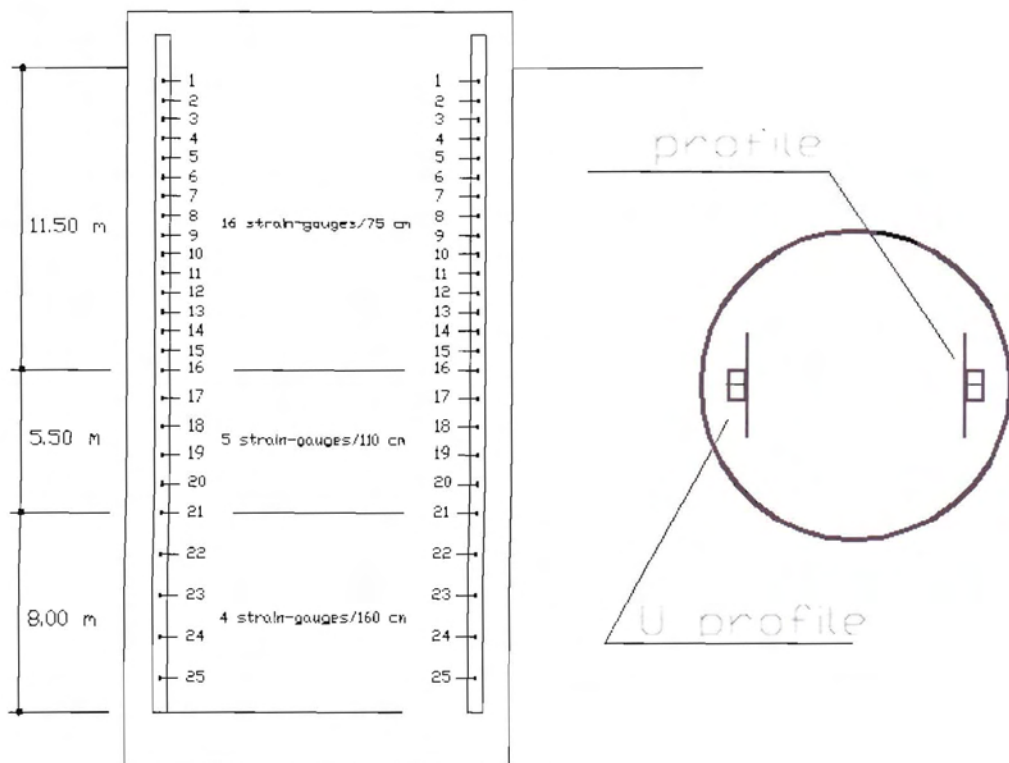

Figure 19. Strain-gauge positioning along the pile length for curvature readings.

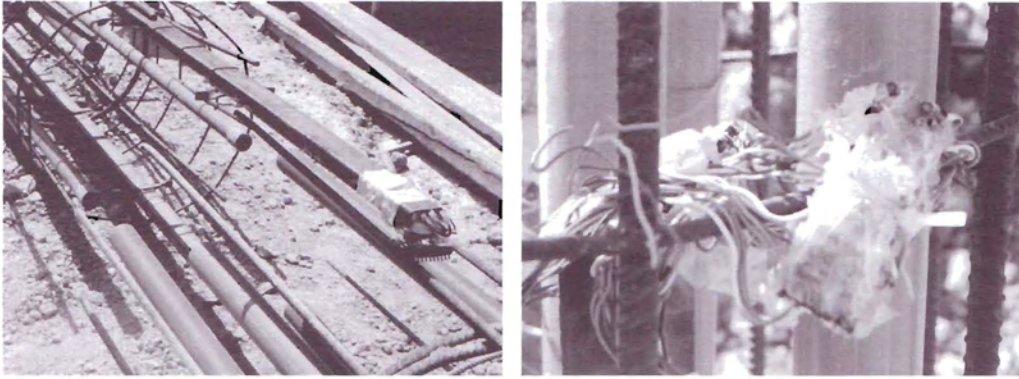

Figure 20. Channel profiles for strain-gauges and electric cables.

4 Soil Characterisation

For the soil characterisation the preparatory geological and geotechnical studies for the design of the TA building of the Engineering Faculty at the University of Catania were made available. These studies contain 8 borehole log-plots and the results of some laboratory tests on soil samples drawn during the borehole operations.

For the reasons previously explained it was not possible to evaluate the mechanical characteristics of the soil through seismic down-hole and cross-hole tests conducted through the central holes in the piles. Thus three new boreholes were drilled as shown in Figure 21 and denoted respectively with BH n°1, BH n°2 and BH n°3. The boreholes of the diameter of 100 mm were perforated up to a depth of 28 m from the ground surface.

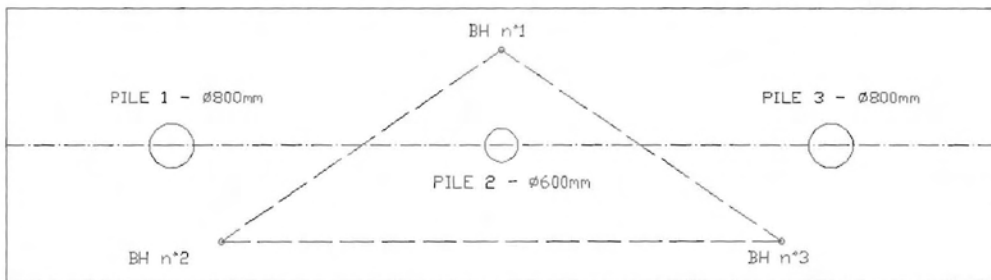

Figure 21. Relative position of piles and boreholes for geophysics tests.

The down-hole and cross-hole tests provided the wave velocity profiles shown in Figure 22. In Figure 22a the longitudinal wave velocity profiles obtained from two different down-hole and cross-hole tests are compared against each other. Down-hole tests usually show coherent

values and so do cross-hole tests. Overall the results of cross-hole and down-hole tests are comparable only at depths larger than about 5 m. For lower depths the longitudinal wave velocities measured by the down-hole and the cross-hole tests differ dramatically. It is not clear which of the two methods provides more accurate results.

The results for the transverse wave velocities are shown in Figure 22b. Once again the velocity profiles of two different down-hole and cross-hole tests are reported for comparison against each other. The results are generally scattered and the coherence between the results of the down-hole and cross-hole tests is rather low. The tests were conducted by GEOCHECK – Catania. It is under consideration whether to require a repeat of the tests by the same operator or others. At the moment, in order to perform numerical analyses, it has been decided to make reference only to the results of the down-hole tests.

During the borehole operations samples of materials as shown in Figure 23 were collected.

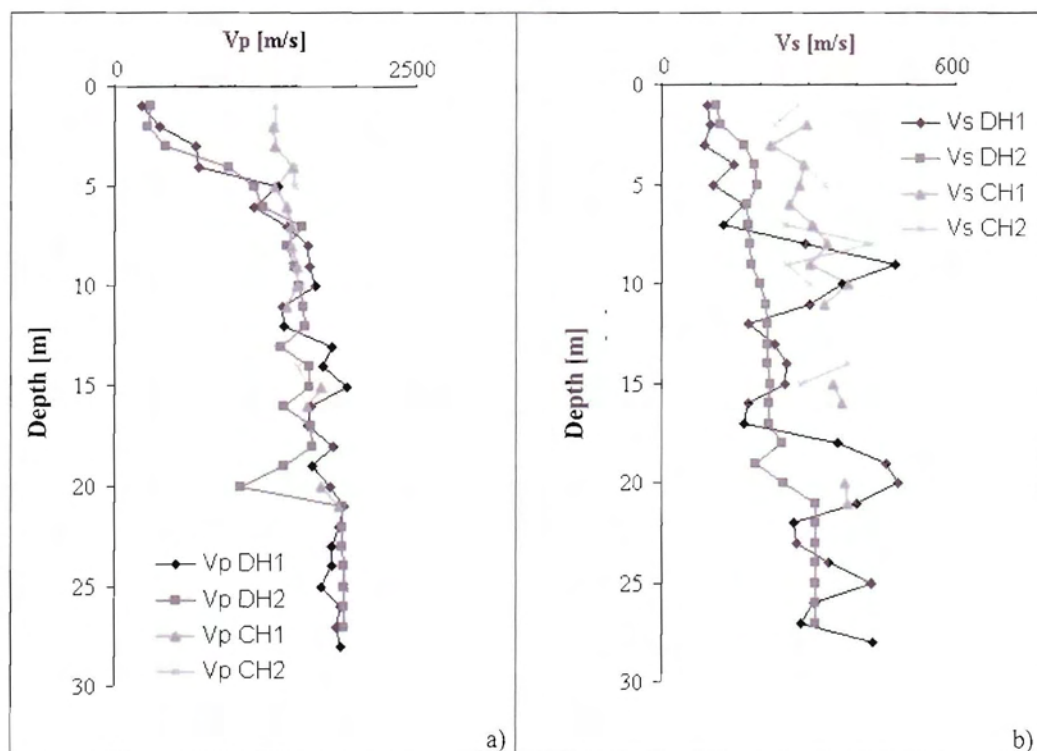

Figure 22. Body wave velocity profiles from down-hole (DH) and cross-hole (CH) tests.

Up to a depth of 7.50 m the presence of yellow clay has been detected; beyond this depth only blue clay has been found. Ultrasonic equipment has been used to measure the longitudinal wave velocity on some of the samples collected.



Figure 23. Clay samples from borehole operations.

The results obtained are collected in Table 1.

Table 1 . Measured parameters for soil samples.

Soil sample	Weight per unit mass [Nm^{-3}]	P- wave velocity [ms^{-1}]
Yellow clay – depth 6 m	19627.27	1454.00
Blue clay – depth 18 m	20717.15	1677.00

The above velocity values are consistent with those obtained at the same depths by down-hole seismic tests.

Table 2 . Parameters for the evaluation of the collapse load of the test system.

Cu : undrained cohesion	150 kNm^{-2}
Distance "a" (see Figure 21)	0.30 m
Plastic moment: 800 mm diameter - pile	823 kNm
Plastic moment: 600 mm diameter - pile	311 kNm

5 Evaluation of the maximum test load

During the preparation of the test programme intended to gather information on the behaviour of the pile-soil system and ultimately to the identification of the dynamic flexibility matrix, it has been seen to be of considerable importance that the piles should not be damaged during the tests as is usually the case under service load conditions and often even under ultimate load conditions. Therefore the collapse load of the test system has been evaluated and optimised in such a way that

the most stressed end pile and the central pile collapse simultaneously, as shown in Figure 24. For that purpose Broms' theory [Viggiani, 1994] has been used together with the parameters collected in Table 2.

The solution is shown in the drawings of Figure 24, where the load H applied at the head of pile n°3 is shown as a function of the lever arm "b" of the couple applied to pile n°2. In Figure 25, one curve provides the collapse load for pile n°2 while the other provides the collapse load for pile n°3. As it may be seen from the figure, there exists only one lever arm for which the two piles collapse for the same value of the horizontal load H . The corresponding values of "H" and "b" provide the required solution. The values obtained by using the parameters of Table 2 are $H=311.51$ kN and $b=1.00$ m. These values have been used for the design of the collars.

To prevent pile damage a safety factor of 2 has been applied to this value to determine the maximum testing load which has been taken equal to 150 kN.

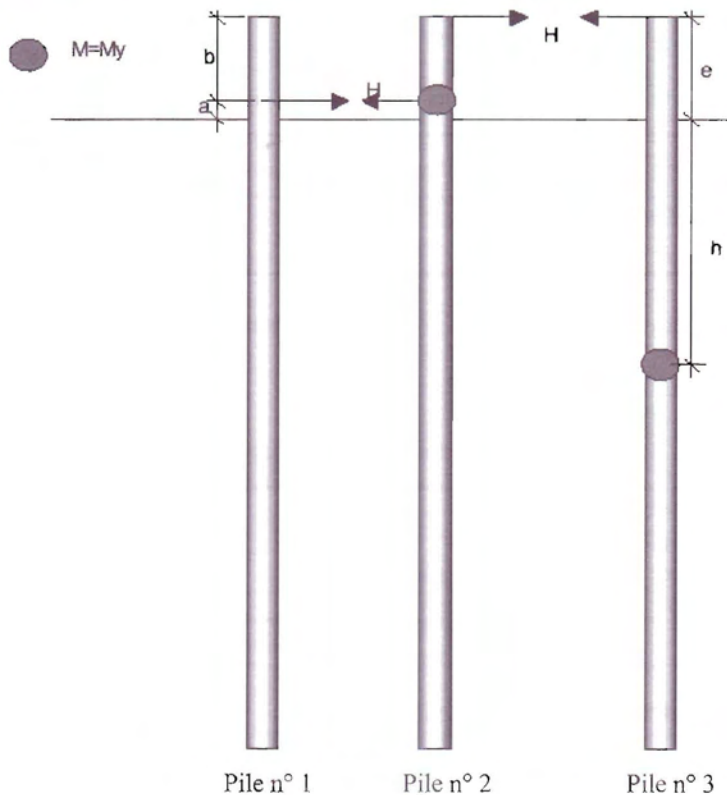

Figure 24. Collapse mechanism of the test system; The lever arm "b" is optimised so that piles n° 2 and n° 3 collapse simultaneously.

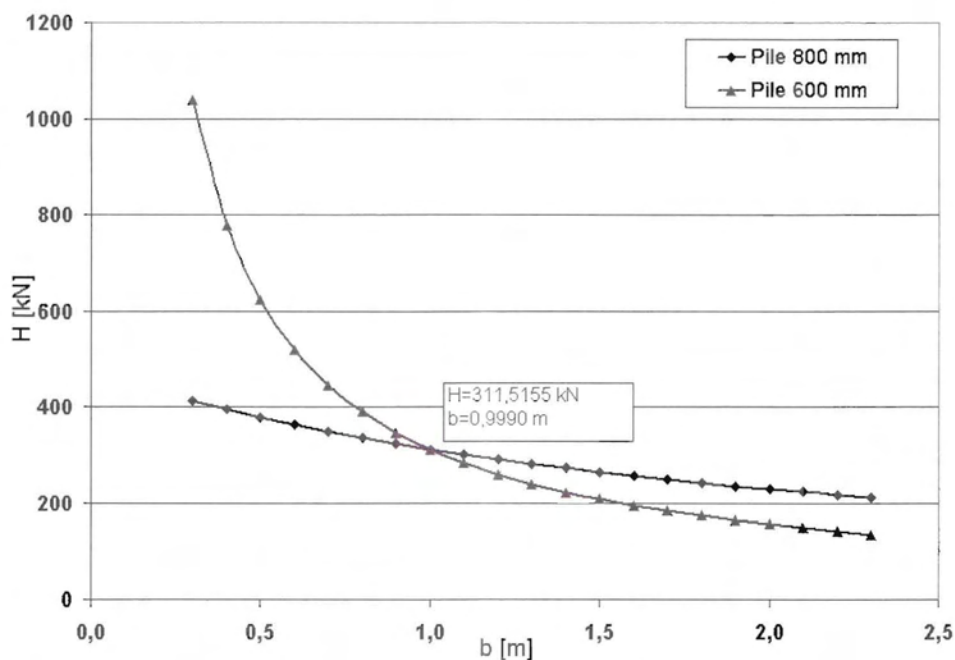

Figure 25. Evaluation of the collapse parameters of the system; Horizontal force “H” and couple “H b” .

6 Measurement and acquisition data systems

As it will be clear from the description of the loading programme, the experimental tests will have both a static and a dynamical character. The measurement and acquisition data systems will be different according to the loading phase considered, whether static or dynamic. In general the measurement devices for static parameters, such as displacements and rotations, will be removed at the beginning of any dynamic loading phase in order to avoid damaging them. In the following the measurement apparatus used for the measurement of static or dynamic parameters will be described separately.

6.1 Measurement and acquisition of static parameters

The physical parameters of static nature that needed to be measured and stored are essentially displacements and rotations at pile heads, and curvatures along the length of the pile stem. With reference to the latter, the distribution of strain-gauges along the length of the pile has already been illustrated when dealing with the test pile description, § 3.2. Here reference will be made to the instrumentation used for the measurement of displacements and rotations and the corresponding acquisition system.

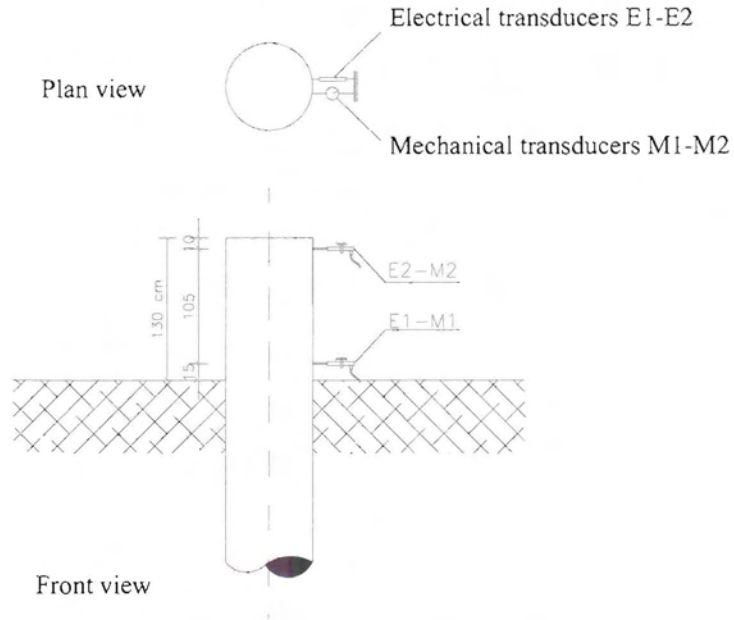

Figure 26. Instrument positioning for displacement and rotation measurements.

Experience gained within the testing laboratory for materials, models and structures at the University of Catania, points to the need for every measurement system to exhibit a certain degree of redundancy, because several instruments may malfunction when they are most needed during a test. In the present case two different measurement systems will be used. A system of electrical transducers with automatic acquisition and a system of mechanical transducers for direct reading and manual recording. For the case in hand the measuring instruments are positioned on pile heads as is shown in the schematic representations of Figure 26. The rotations are measured indirectly by the knowledge of the displacement differential and of the distance between measuring instruments.

Data relating to the mechanical displacement transducers is stored immediately after reading in pre-prepared data sheets. Data relative to the electrical transducers is acquired continuously by means of an HBM data acquisition system, type UPM 60.

The technical characteristics of the displacement transducers are shown in Table 3.

Table 3 . Technical characteristics of displacement transducers and strain-gauges.

Electrical transducers HBM WA - maximum range 20 – 50 mm	Resolution 10^{-3} mm
Mechanical transducers - maximum range 50 mm	Resolution 10^{-2} mm
Strain-gauge PFL10	Resolution $1\mu\text{s}$

The strain-gauge signals are acquired by the same data acquisition system used for the electrical displacement transducers: HBM, type UPM 60. The technical characteristics of the strain-gauges are given in Table 3.

6.2 Measurement and acquisition of dynamical parameters

Two NOVATECH load cells, model F204, suitably modified for the present application, are used for the measurement of the traction in the two branches of the load transmission steel rope. Fourteen SETRA model 141B accelerometers are used for the measurement of the acceleration at the pile heads. Velocities and displacements are obtained by successive integrations. Rotations are obtained indirectly by the evaluation of differential displacements and the distance between measurement points. The positioning of the load cells for the measurement of the traction in the two branches of the steel rope has been dealt with in detail in § 2.5. The typical positioning of the accelerometers at pile heads is shown in the schematic representation of Figure 27. Accelerometers 1 and 2 are positioned to measure horizontal accelerations of the pile head and, after integration, velocities and displacements. The duplication obeys to the usual redundancy principle already mentioned when describing the static instrumentation. Accelerometers 3 and 4 are dedicated to the measurement of vertical accelerations and, indirectly, corresponding velocities and displacements.

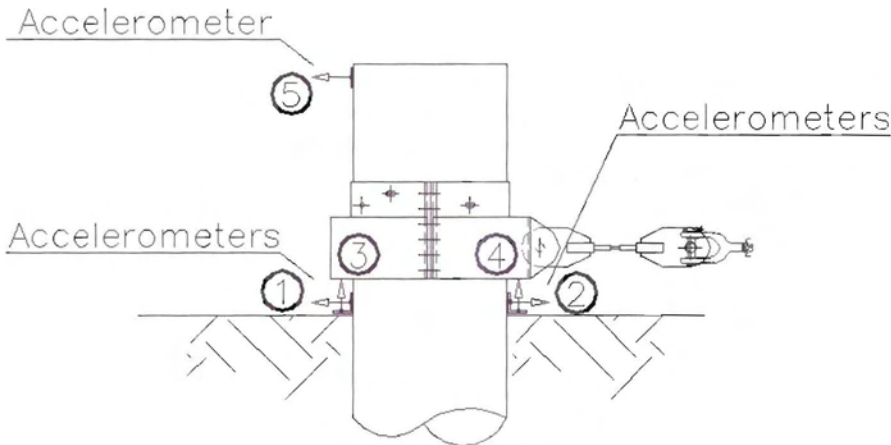

Figure 27. Positioning of accelerometers on pile heads.

Their main function is that of providing a differential measure of the rotation of the pile head. It is possible that the corresponding accelerations may turn out to be too low and there is, presently, no certainty that the results obtained will be sufficiently reliable. This explains the positioning of accelerometer 5, which together with accelerometers 1 and/or 2 should also provide an indirect measurement of the rotation of the pile head. This additional accelerometer positioning corresponds to the redundancy principle already quoted. A crosscheck of both

horizontal displacements and rotations becomes in this way possible, provided that all accelerometers function properly and the acquired signals are sufficiently reliable. The depicted accelerometer disposition is the test design one. When the actual testing phase begins, the results of a few dynamical tests will be carefully analysed and any suitable correction to the present disposition will be adopted if required. The technical data for the load cells have already been given in § 2.5, those for the accelerometers are given in Table 4.

The signals produced by the accelerometers are acquired by an AT-MIO-16X NATIONAL INSTRUMENTS card mounted on personal computer.

Table 4 . Technical characteristics of SETRA 141B accelerometers.

Nominal sensitivity	0.5V/g
Utilisation range	± 2 g
Resolution	10^{-4} g

7 Testing programme

The testing programme considers three maximum load levels respectively equal to 50 kN, 100 kN e 150 kN. For each load level a static test will be performed where the load (H force) will be increased in a pseudo-static fashion up to the maximum considered value. Once the maximum value has been reached, the load is maintained at that level for the next 24 hours in order to capture the time dependent characteristics of the soil-pile system (creep test). Once a static equilibrium configuration has been reached the load is suddenly increased to activate the quick release device (fuse). The subsequent phase of free vibration, together with the phase of rapid load growth, constitutes the dynamical aspect of the testing programme. Once the equilibrium configuration has been reached (rest condition of the system) the procedure is repeated until 8 test realisations are achieved. After the lower load level phase (maximum load of 50 kN) has been completed, the intermediate phase is executed (maximum load of 100kN) and finally the last phase with a maximum load of 150 kN ends the test programme.

8 Conclusions

An experimental device for static and/or dynamical tests on foundation piles has been described. The device allows for the application of horizontal forces to two test piles and of a couple to the third test pile. Besides static tests, impulsive-type dynamical tests may be performed with the acquisition of the dynamical response in the time domain. The tests performed for the mechanical characterisation of piles and soil have also been described. The instrumentation for the measurement of the response within the pile stem and at the pile heads has been discussed and the reasons for its positioning explained.

Overall the test programme should allow the gathering of information on the short and long term static behaviour of the pile-soil system and on the dynamical behaviour of the same system.

The experimental results will be useful in the validation and calibration of numerical algorithms for the analysis of the static and/or dynamical behaviour of the soil-pile system and of structures and buildings founded on piles (Finite Elements and/or Boundary Element based numerical codes).

The results may also be used in the formulation and/or validation of simplified models representing the pile-soil system.

References

- Relazione Geologica e Geognostica** (1998), Edificio per la Didattica della Facoltà di Ingegneria nel N.C.U. di S. Sofia. Università degli Studi di Catania, Istituto di Geologia e Geofisica.
- Viggiani C.** (1994). *Fondazioni*. Ed. CUEN.
- Vinciprova F., Maeso Fortuny O., Aznárez J. J. and Oliveto G.**, Interaction of BEM analysis and experimental testing on Pile-Soil Systems, in this volume.

INTERNATIONAL CENTRE FOR MECHANICAL SCIENCES

COURSES AND LECTURES - No. 471



PROBLEMS IN STRUCTURAL
IDENTIFICATION AND DIAGNOSTICS:
GENERAL ASPECTS AND APPLICATIONS

MURST Project n. MM08342598 - COFIN 2000

EDITED BY

CESARE DAVINI
UNIVERSITY OF UDINE, ITALY

ERASMO VIOLA
UNIVERSITY OF BOLOGNA, ITALY



SpringerWienNewYork

This volume contains 131 illustrations

This work is subject to copyright.
All rights are reserved,
whether the whole or part of the material is concerned
specifically those of translation, reprinting, re-use of illustrations,
broadcasting, reproduction by photocopying machine
or similar means, and storage in data banks.

© 2003 by CISM, Udine

Printed in Italy
SPIN 10970591

In order to make this volume available as economically and as rapidly as possible the authors' typescripts have been reproduced in their original forms. This method unfortunately has its typographical limitations but it is hoped that they in no way distract the reader.

ISBN 3-211-20492-X Springer-Verlag Wien New York